

# FOLDING FABRIC COUNTER

The ideal fabric counter for promotions and exhibitions



**FOLDING FABRIC COUNTER**

**COMPONENTS**

**FOLDING FABRIC COUNTER**

**ZF800/R.90**

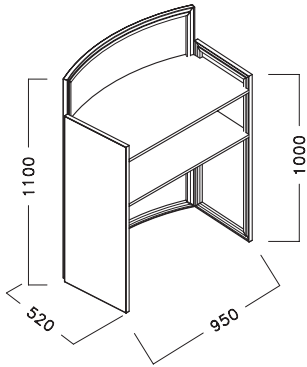

Matt anodised aluminium frame with white timber top and shelf. Fabric sold separately.  
950 x 520 x 1100 mm (width/depth/height)  
**16 kg**

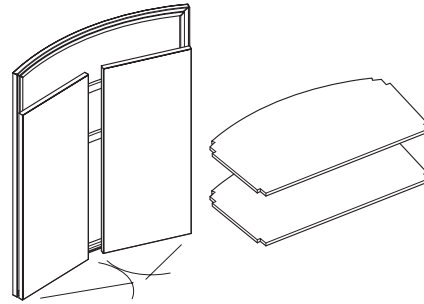

**SINGLE SIDED TFS PROFILE 22mm**

**ZF22.01**

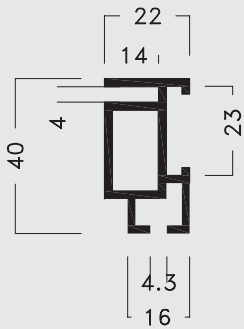

With groove to fix fabric panels in connection with silicone welt, M1313.  
Matt anodised aluminium, 6000mm  
**4.776kg**

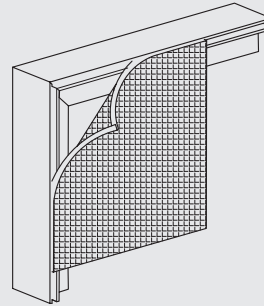

**INTERNAL CORNER CONNECTOR**

**M1335.37**

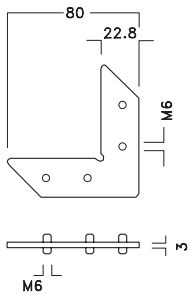

For connection of fabric frame extrusion ZF22.  
Steel  
**0.06kg**

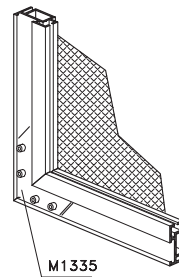

**WELT**

**M1313.50**

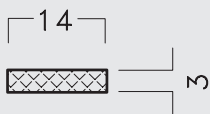

For fixing fabric to all fabric suspension and frame extrusions.  
Silicone, 100m roll  
**5.31kg**

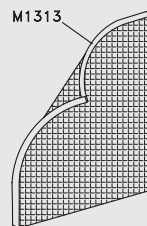

**FOLDING FABRIC COUNTER**

**COMPONENTS**

**HINGE**

**W545.01**

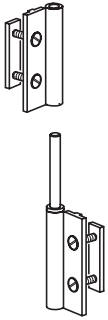

For fixing to drilled ZF22.  
Aluminium  
0.075kg

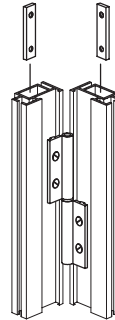

**COUNTER TOP/SHELF**

**ZF 800/R-SHELF.30**

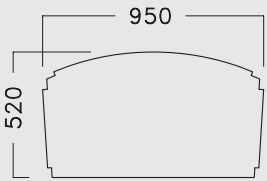

White laminate.  
950 x 520 mm  
5.6kg

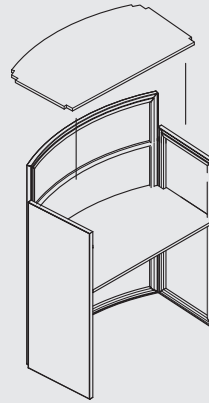

**SIZING GRAPHICS**

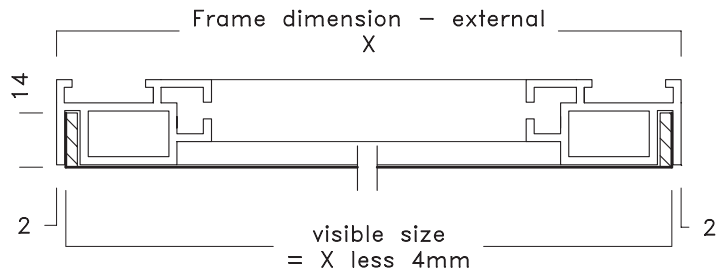
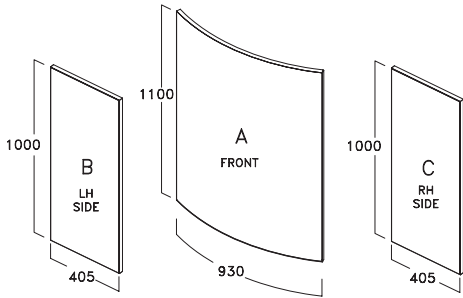

external frame dimensions shown (X)

**EXAMPLE**



**FRONT**



**EASY TO STORE**



**EASY TO TRANSPORT**



**HINGE DETAIL**

**FOLDING FABRIC COUNTER**

**COMPONENTS**

**FOLDING FABRIC COUNTER**

**ZF800/R.90**

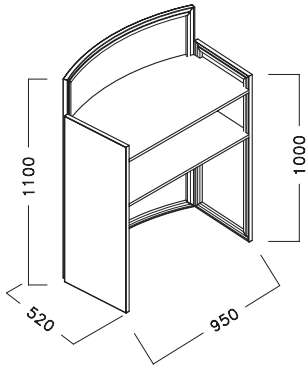

Matt anodised aluminium frame with white timber top and shelf. Fabric sold separately.  
950 x 520 x 1100 mm (width/depth/height)  
**16 kg**

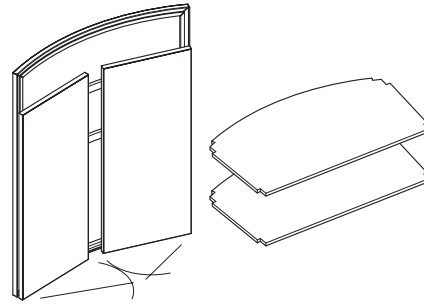

**SINGLE SIDED TFS PROFILE 22mm**

**ZF22.01**

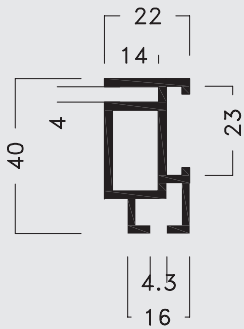

With groove to fix fabric panels in connection with silicone welt, M1313.  
Matt anodised aluminium, 6000mm  
**4.776kg**

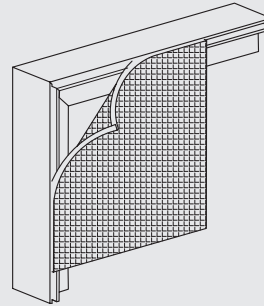

**INTERNAL CORNER CONNECTOR**

**M1335.37**

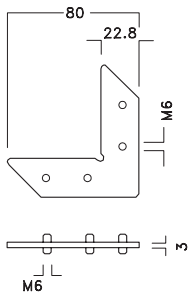

For connection of fabric frame extrusion ZF22.  
Steel  
**0.06kg**

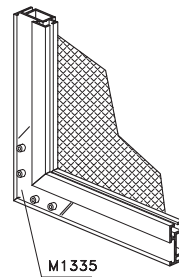

**WELT**

**M1313.50**

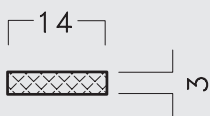

For fixing fabric to all fabric suspension and frame extrusions.  
Silicone, 100m roll  
**5.31kg**

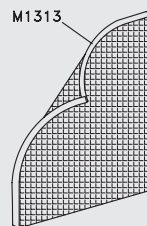

**FOLDING FABRIC COUNTER**

**COMPONENTS**

**HINGE**

**W545.01**

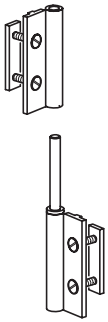

For fixing to drilled ZF22.  
Aluminium  
0.075kg

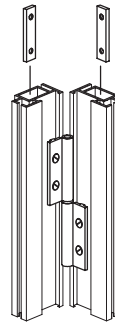

**COUNTER TOP/SHELF**

**ZF 800/R-SHELF.30**

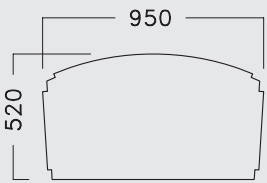

White laminate.  
950 x 520 mm  
5.6kg

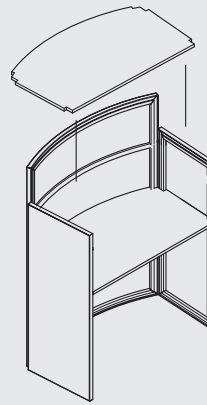

**SIZING GRAPHICS**

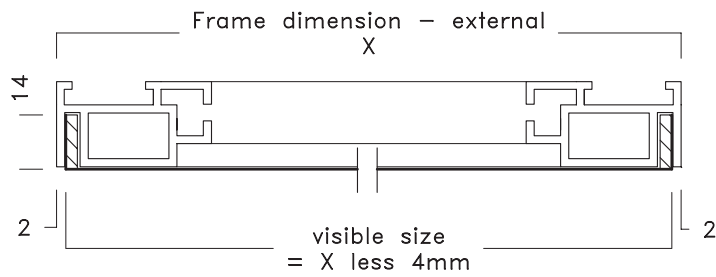
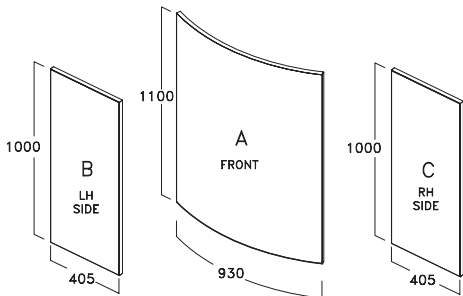

external frame dimensions shown (X)

**EXAMPLE**



**FRONT**



**EASY TO STORE**



**EASY TO TRANSPORT**



**HINGE DETAIL**